



Comhairle Cathrach
Bhaile Átha Cliath
Dublin City Council

DUBLIN DOCKLANDS AREA OPENING BRIDGES

BLOOD STONEY BRIDGE



Consultation Information Report

DDA-BSB-REP-RPS-226

15 November 2019

A RPS COWI Joint Venture



Working with:

Knight Architects



Document Control Sheet

| Rev. | Status | Date | By | Check | Approved |
|------|--------|-----------|----|-------|----------|
| V01 | Final | 11 Nov 19 | CR | PK | PK |
| | | | | | |
| | | | | | |
| | | | | | |

Document prepared and controlled by:

RPS

West Pier Business Campus
 Dun Laoghaire
 Co Dublin
 Ireland

Tel: +351 (1) 488 2900
 Email ireland@rpsgroup.com
 Web: www.rpsgroup.com

RPS

West Pier Business Campus
 Dun Laoghaire
 Co Dublin
 Ireland

Tel: +353 1488 2900
 Email ireland@rpsgroup.com
 Web: www.rpsgroup.com

COWI

Bevis Marks House
 24 Bevis Marks
 London EC3A 7JB

Tel: +44 (0)20 7940 7600
 Email: info_uk@cowi.com
 Web: www.cowiuk.com - www.cowi.com

Copyright RPS COWI Joint Venture. All rights reserved.

The report has been prepared for the exclusive use of our client and unless otherwise agreed in writing by RPS Group Limited or COWI UK Limited no other party may use, make use of or rely on the contents of this report.

The report has been compiled using the resources agreed with the client and in accordance with the scope of work agreed with the client. No liability is accepted by RPS Group Limited or COWI UK Limited for any use of this report, other than the purpose for which it was prepared.

RPS Group Limited and COWI UK Limited accepts no responsibility for any documents or information supplied to RPS Group Limited or COWI UK Limited by others and no legal liability arising from the use by others of opinions or data contained in this report. It is expressly stated that no independent verification of any documents or information supplied by others has been made.

RPS Group Limited and COWI UK Limited have used reasonable skill, care and diligence in compiling this report and no warranty is provided as to the report's accuracy.

No part of this report may be copied or reproduced, by any means, without the written permission of the RPS COWI Joint Venture

Contents

1 Introduction 1

 1.1 Background..... 1

2 Need for the Scheme..... 1

 2.1 Scheme Location..... 2

 2.2 Structural Form..... 3

 2.3 Proposed Bridge Structure..... 4

 2.4 Plant Rooms 8

 2.5 Bridge Approaches 9

 2.6 Main Impacts 10

 2.7 Main Benefits..... 11

 2.8 Timeline for Proposed Scheme..... 11

Appendix A Drawings..... 13

Drawing DDA-BSB-DRG-COWI-1005-v1.0 14

Drawing DDA-BSB-DRG-RPS-4051-Rev 07..... 15

Figure 2.1 – Proposed Bridge Location 3

Figure 2.2 – Concept Montage 4

Figure 2.3 – Plan View Montage showing segregated pedestrian and cycleways..... 5

Figure 2.4 – Aerial View Montage showing segregated pedestrian and cycleways..... 5

Figure 2.5 – Span arrangement (40m - 40.7m - 40m) providing a 31.5m wide navigation envelope with unlimited headroom 7

Figure 2.6 – Elevation Open Montage..... 8

Figure 2.7 – Proposed Campshire and Junction Layout - showing segregated cycleways and footways on the bridge and campshire 10

Figure 2.8 – North Campshire Cross Section..... 10

Figure 2.9 – South Campshire Cross Section 10

[This page has been left blank intentionally].

1 Introduction

1.1 Background

Dublin City Council are progressing the design of a new pedestrian and cyclist bridge over the River Liffey in the Docklands area of the city. The new bridge will span from Blood Stoney Road at Sir John Rogerson's Quay (in the South) to New Wapping Street, North Wall Quay (in the North).

The proposed bridge is located within the North Lotts and Grand Canal SDZ Planning Scheme 2014 which was approved by the Board on 16th May 2014. The North Lotts and Grand Canal Planning Scheme 2014 includes the provision of two new pedestrian bridges across the River Liffey. The SDZ Planning Scheme is currently subject to a proposed amendment in relation to a revised pedestrian / cycle bridge location across the River Liffey.

Subject to receiving approval for the amended bridge location a planning application will be made by Dublin City Council for the new bridge, in accordance with Section 51A of the Roads Act, 1993 to An Bord Pleanála. The application will be accompanied by an Environmental Impact Assessment Report (EIAR) and Natura Impact Statement (NIS).

2 Need for the Scheme

The nearest existing bridges to the proposed Blood Stoney Bridge are the Samuel Beckett Bridge to the West, and the East Link Bridge to the East. Both of these are primarily vehicular crossings and are already operating at full capacity for pedestrian and cyclists at peak times¹.

The SDZ Planning Scheme 2014 contained two new pedestrian bridges across the River Liffey. The original bridge location indicated in the SDZ planning scheme showed a bridge linking Forbes Street to Park Lane. Preliminary studies for a new bridge near Forbes Street commenced in 2015. The North Lotts and Grand Canal SDZ Planning Scheme did not explicitly consider the interaction between the proposed bridge at Forbes Street and planned DART Underground. Proposed Scheme. The preliminary studies identified

¹ ARUP (May 2015), Proposed Liffey Bridge Pedestrian Study, River Liffey Bridge Pedestrian Study Report_Final

significant technical and procedural challenges related to constructing a bridge above the proposed Dublin Area Rapid Transit (DART) Underground.

A bridge at the Forbes St location would have an unacceptable detrimental effect on the DART Underground project. This has led DCC and the NTA to reject Forbes Street as a viable location for the bridge.

Further studies investigated potential locations for the bridge. Of these, Blood Stoney Road was identified as the most favourable for the following reasons:

- Removes all interference with the DART Underground project;
- Provides a more uniform spacing of river crossing;
- Eastward shift in desire lines for pedestrian and cyclists due to development of North Docks Area;
- Traffic modelling figures predict very high usage figures for the Blood Stoney Bridge location.

2.1 Scheme Location

The site is situated in the historic Dublin Docklands Area, a largely flat urban environment. The proposed bridge is surrounded by commercial and residential buildings, up to eight storeys in height. Notable adjacent buildings include the Central Bank of Ireland on New Wapping Street and The Convention Centre Dublin on the North Quay.

Blood Stoney Bridge is envisaged as being a continuation of the Campshire environment for cyclists and pedestrians.

The proposed bridge crosses the River Liffey upstream of the confluence with its tributary, River Dodder in the Docklands area of Dublin. The Blood Stoney Bridge will connect the two river banks at the projection of the Blood Stoney Road and New Wapping Street, at Sir John Rogerson's Quay (in the South) and North Wall Quay (in the North), respectively (**Figure 2.1**). In this area the river channel is c.125m wide.

The bridge will be a dedicated pedestrian and cycling bridge with a 4m wide segregated cycleway and two footways, each with an average width of 3m. The bridge will be an opening bridge to allow for passing river traffic, maintaining unlimited head clearance across the full width of the navigation channel (31.5m) in the open position.



Figure 2.1-Location map showing bridge spanning from New Wapping Street to Blood Stoney Road

Figure 2.1 – Proposed Bridge Location

2.2 Structural Form

A concept montage of the proposed bridge is shown in **Figure 2.2**. The structural form of the bridge is driven by the following objectives:

- Provide an architecturally sensitive bridge in an optimum location that adheres to the principles of universal design;
- Provide high quality linkages to adjacent cycling and pedestrian facilities;
- Provide unlimited head clearance when the bridge is opened;
- The width of the navigation channel must be at least equal to that of the East Link Bridge (32m);
- The gradients of the bridge deck and any access ramps must be in accordance with best practice for cyclist and disabled access;
- The design must provide lasting quality that is also economic to build, maintain and operate. The bridge must be robust and sufficiently resilient to future flood events;
- A two-way cycle lane with a total width of 4.0m is required. The total width of pedestrian footways is between 2.5m and 4m;

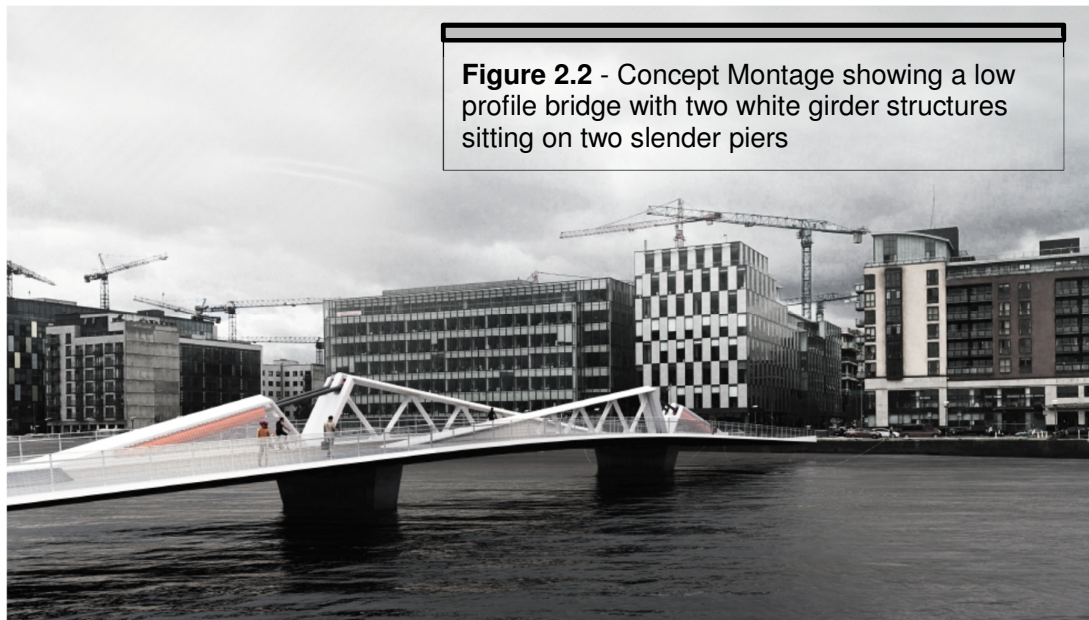

Figure 2.2 – Concept Montage

2.3 Proposed Bridge Structure

The proposed plan arrangement of the bridge and approach ramps is presented in Drawing DDA-BSB-DRG-COWI-1005-v1.0 (**Appendix A**). A plan view and aerial montage of the bridge is shown in **Figure 2.3** and **Figure 2.4**. The bridge has a central cycleway with segregated footways on either side. The bridge has a total of three spans with the central span opening using a twin bascule mechanism. The primary support for the lifting spans is provided by triangle trusses that run between the cycleway and footways.

The bridge is approximately 125m long. The deck is typically up to 1 m thick below finished footway level, supported either side of the navigation channel by central piers on piled foundations. The ends of the bridge are supported by integral piers placed in front of the quay walls. This has been done to minimise the impact to the quay walls which are protected structures under national monuments legislation.

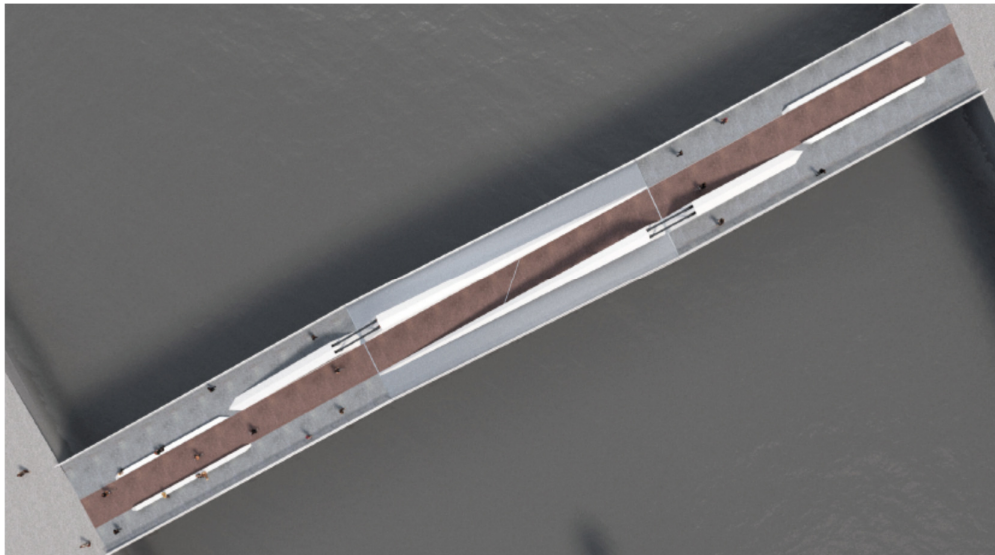

Figure 2.3 – Plan View Montage showing segregated pedestrian and cycleways



Figure 2.4 – Aerial View Montage showing segregated pedestrian and cycleways

Geometry

The bridge will carry pedestrians and cyclists in both directions with the cycle path segregated from the footpaths. The minimum functional widths for the bridge are as follows and are shown in Drawing DDA-BSB-DRG-COWI-1005-v1.0 (**Appendix A**):

- One two-way cycleway with minimum clear width = 4.0m
- Two footways. For each footway the minimum clear width shall be:

- 3.0m when adjacent to any obstacles greater than 750mm in height (excluding the edge parapet)
 - 2.5m when adjacent to any obstacle/structure less than 750mm in height.
- The highest point of the truss is approximately 4.2m above the surface of the deck.

Vertical and Horizontal Alignment

The geometric limits for the vertical alignment of the top surface of the deck in order to satisfy accessibility and drainage requirements are defined as follows:

- Longitudinal geometric limit – Maximum 1 in 25 over 70 m (1 in 30 preferred); and,
- Transverse geometric limit – Maximum 1 in 50 (preferred).

The bridge's longitudinal gradient adopts a 3% fall towards both the North Wall Quay and Sir John Rogerson's Quay.

Span Arrangement

The bridge will be a 3-span steel bridge deck. The layout is symmetric comprising a 40m long central opening span and fixed spans either side. The span arrangement is approximately: 40m-40.7m-40m from South to North, refer to **Figure 2.5**.

The proposed bascule solution was chosen so that the mechanism is accessible from the fixed span to simplify maintenance and improve safety. A twin bascule was favoured over a single bascule arrangement given the required span length and a wish for the bridge to maintain a human scale.

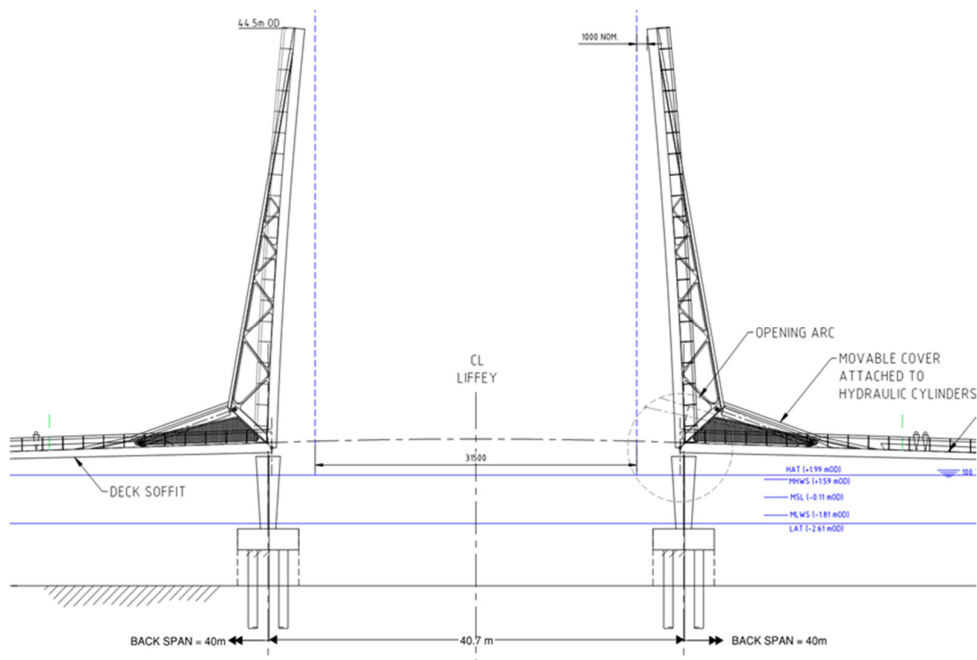

Figure 2.5 – Span arrangement (40m - 40.7m - 40m) providing a 31.5m wide navigation envelope with unlimited headroom

Superstructure

The bridge has a steel orthotropic deck; a deck formed of relatively thin steel plates with internal longitudinal stiffeners.

The central portion of the deck is a closed box with transverse cantilevers supporting the footways. In the fixed spans, structural boxes separate the cycleway and footways and form benches for seating. The lifting spans are supported by a truss that is triangular in shape when viewed in elevation.

An aluminium decking system is proposed for the footways of the moving span to reduce weight.

Substructure

The bridge's abutment piers are placed in front of the existing quay walls. The quayside abutment piers are monolithic with the deck and are constructed from reinforced concrete with a permanent steel liner. The use of stainless steel for the liner will be investigated during detailed design.

The two central river piers will be constructed from reinforced concrete.

Bridge Opening

The proposed bridge scheme is a twin lifting bascule. During bridge opening, electrical motors pump hydraulic fluid into hydraulic rams mounted above the deck surface which rotate the bridge around a horizontal axis. The bridge opening elevation montage is shown in **Figure 2.6**.

The deck is raised by hydraulic rams connected to the top chord of the truss and anchored in the fixed spans. During lifting the rams shorten, rotating the central deck about a pivot below deck level.

Pedestrian barriers in the back spans are deployed prior to the bridge lifting to halt pedestrians and cyclists.



Figure 2.6 – Elevation Open Montage

2.4 Plant Rooms

The electrical power for the bridge operation will be supplied directly to the new plant rooms (one on each quay) from new substations. The plant rooms shall be located within 50m from the tail of the bridge. The plant room and substation will be incorporated into a single building.

2.5 Bridge Approaches

It is important to consider the bridge as a piece of public realm that integrates into the design of the Campshires both North and South. The Campshires are stretches of cobbled paths between the quay and road on the north and south of Dublin's Quays. The Campshires are a unique piece of heritage that are best appreciated when people walk along them.

North Wall Quay (the R801) is a four-lane carriageway, with two lanes in both directions running east-west adjacent (and to the north of) the River Liffey. The posted speed limit is 50kph. It's T-junction with New Wapping Street is signalised and includes pedestrian crossings on each of the three arms of the junction. North Wall Quay has an off-road cycle track and a pedestrianised area to the south, including seating areas and trees. An existing hand rail runs along the dock wall, providing physical separation between the footway and the River Liffey.

Sir John Rogerson's Quay is a two-lane carriageway with a posted speed limit of 50kph, with one lane in both directions running east-west adjacent (and to the south of) the River Liffey. It's T-junction with Blood Stoney Road operates under priority control and provides an uncontrolled pedestrian crossing of Blood Stoney Road. A raised table is located on Blood Stoney Road at its junction with Sir John Rogerson's Quay. Indented car parking is provided on each arm of the T-Junction. There is currently no handrail on the dock wall, so there is no physical separation between the footway and the River Liffey. Sir John Rogerson's Quay has an off-road cycle track and a pedestrianised area to the north.

The signalised junction at New Wapping Street shall remain, with modifications being made to the segregated cycle and pedestrian areas on the footway. However, the priority-controlled T-Junction at Blood Stoney Road will be up-graded to include traffic signals, which will formally tie-in to the bridge's southerly landing area. Cycle signals and a stacking space for cyclists are proposed at both the North Wall Quay/New Wapping Street and the Sir John Rogerson's Quay/Blood Stoney Road junctions, which will support cyclists wishing to continue north or south of the bridge.

Fully signalised pedestrian crossings will be provided at each interaction with the cycle track on the campshires, to allow vulnerable users to move safely across the junctions. The proposed campshire and junction layouts are shown in **Figures 2.7 – 2.9** and shown in Drawing DDA-BSB-DRG-RPS-4051-Rev 07 (**Appendix A**).

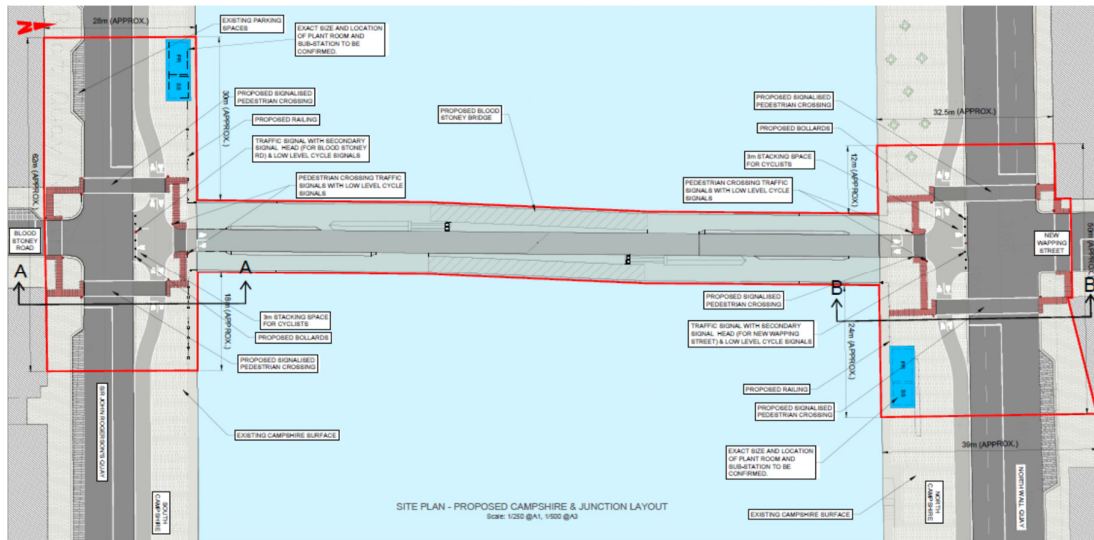

Figure 2.7 – Proposed Campshire and Junction Layout - showing segregated cycleways and footways on the bridge and campshire

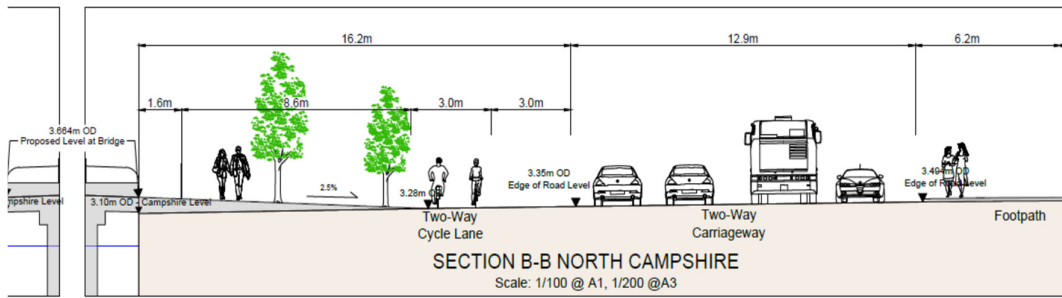

Figure 2.8 – North Campshire Cross Section

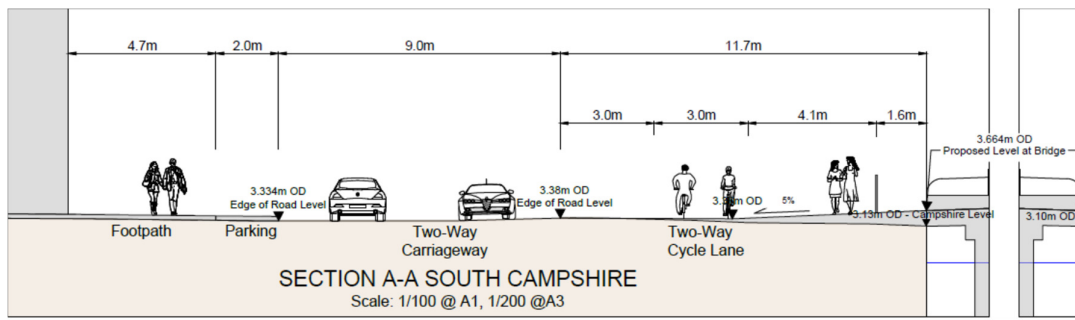

Figure 2.9 – South Campshire Cross Section

2.6 Main Impacts

- By promoting sustainable modes of transport, the bridge will reduce dependency on private cars and will result in improved air quality as vehicle journeys are replaced by more sustainable alternatives.

- There will be traffic generation from construction vehicles including cranes and other general construction traffic. The contractor will be required to prepare a Construction Environmental Management Plan (CEMP) and associated Traffic Management Plan (TMP) that maximises the safety of the workforce and the public and minimises traffic delays, disruption and maintain access to properties.

2.7 Main Benefits

- The bridge will improve connectivity between the South and North Docklands and is a necessary condition for releasing the potential of the strategic development zone.
- The proposed bridge shall promote physical activity and sustainable modes of transport.
- The provision of a new crossing of the Liffey shall improve city permeability for pedestrians and cyclists.
- The new crossing will successfully alleviate congestion and reduce the risk of collisions on the Samuel Becket Bridge and Thomas Clarke Bridge.
- The provision of a high quality, dedicated bicycle and pedestrian bridge facilitates segregation of vulnerable road users from vehicular traffic with associated road safety benefits. On the bridge, pedestrian and cyclists are physically segregated to reduce the risk of collisions. The design shall apply the principles of universal design to cater for all users including those with accessibility requirements.
- Cycle signals are proposed at both the North Wall Quay/New Wapping Street and the Sir John Rogerson's Quay/Blood Stoney Road junctions, which will support cyclists wishing to continue north or south of the bridge.
- The location of the bridge connects with the Liffey Cycle routes and planned Greenways and provides a vital additional crossing point in the Docklands.

2.8 Timeline for Proposed Scheme

It is proposed to submit the planning application to An Bord Pleanála in early 2020, subject to receiving approval for the amendment to the North Lotts and Grand Canal SDZ Planning

Scheme. Assuming the scheme is approved, it is anticipated that construction will start in mid-2021 and will take approximately 18 months to complete.

Appendix A Drawings

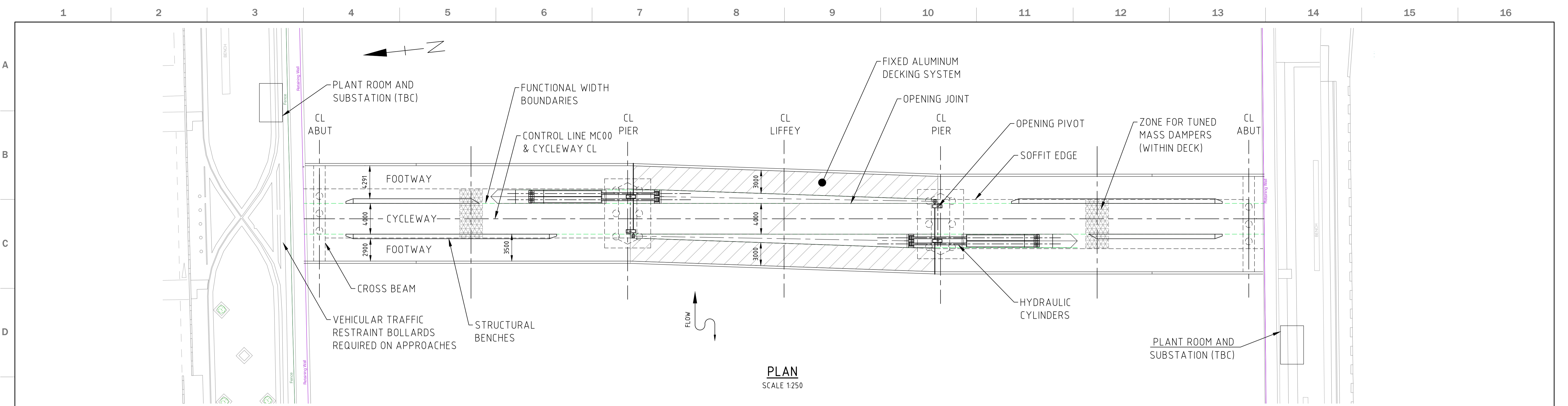

PLAN
SCALE 1:250

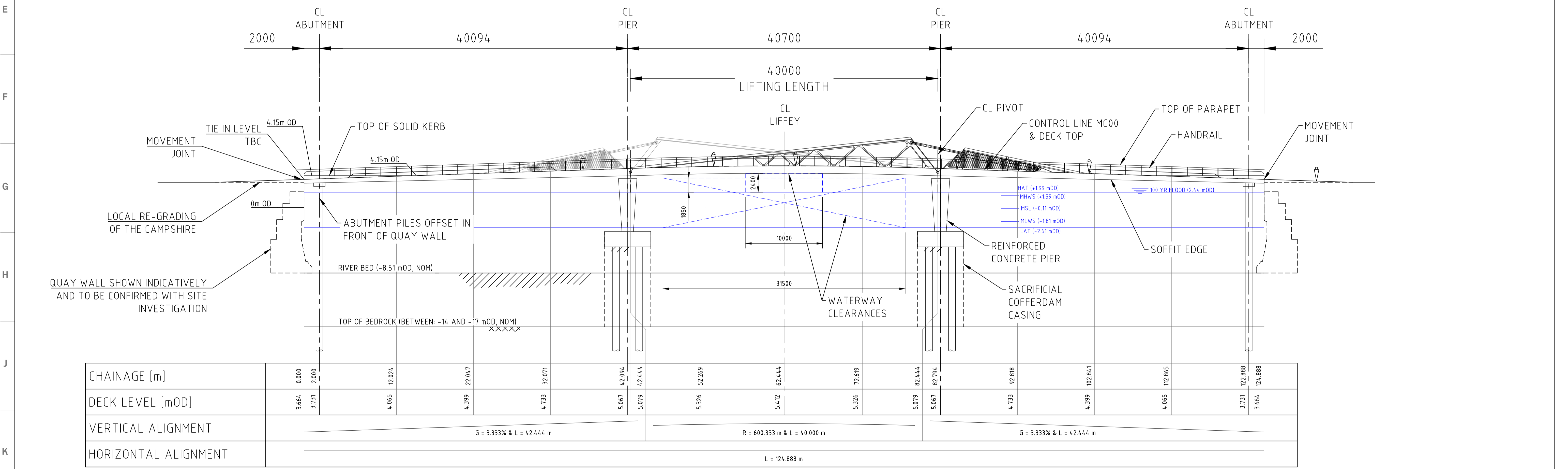

LONGITUDINAL SECTION - CONTROL LINE MC00
SCALE 1:250

| | | | | | | | | | | | | | | | | |
|----------------------|---------------------------|-------|--------|--------|--------|------------------------------|--------|--------|--------|--------|---------------------------|--------|---------|---------|---------|---------|
| CHAINAGE [m] | 0.000 | 2.000 | 12.024 | 22.047 | 32.071 | 42.094 | 42.444 | 52.269 | 62.444 | 72.619 | 82.794 | 92.818 | 102.841 | 112.865 | 122.888 | 124.888 |
| DECK LEVEL [mOD] | 3.664 | 3.731 | 4.065 | 4.399 | 4.733 | 5.067 | 5.079 | 5.326 | 5.412 | 5.326 | 5.079 | 4.733 | 4.399 | 4.065 | 3.731 | 3.664 |
| VERTICAL ALIGNMENT | G = 3.333% & L = 42.444 m | | | | | R = 600.333 m & L = 40.000 m | | | | | G = 3.333% & L = 42.444 m | | | | | |
| HORIZONTAL ALIGNMENT | L = 124.888 m | | | | | | | | | | | | | | | |

PRELIMINARY

NOTES:
 1. THESE DRAWINGS SHALL BE READ IN CONJUNCTION WITH THE PRELIMINARY DESIGN REPORT.
 2. LEVELS SHOWN AS mOD. REFER MALIN HEAD OD DATUM.
 3. PILE LENGTHS TO BE CONFIRMED ONCE GROUND INVESTIGATION INFORMATION IS AVAILABLE.
 4. SHIP IMPACT LOADS ARE TO BE CONFIRMED. PROTECTION WILL LIKELY BE REQUIRED FOR THE ABUTMENT PILES.
 5. THE 100 YR FLOOD HEIGHT IS BASED ON THE 1% AEP LEVEL (FLUVIAL) DOCUMENTED IN REVISION 3 OF THE FLOODING/INTERIM ADVICE NOTE DATED: 27/10/2017. FLOOD HEIGHTS AND VELOCITIES ARE TO BE CONFIRMED FROM THE HYDRAULIC STUDY.
 6. RIVER BED SCOUR PROTECTION DETAILS FOR THE RIVER BED ARE TO BE CONFIRMED.

Designers:

 Knight Architects
 E: ireland@rpsgroup.com; or info_uk@cowi.com

Client:

 Comhairle Cathrach
 Bhaile Átha Cliath
 Dublin City Council

| | | | |
|------|----------|----------------------------|---------------------|
| 1.0 | 04/06/18 | PRELIMINARY DESIGN ISSUE | CNAS/CNAS/OLSS/PASS |
| 0.0 | 18/05/18 | DRAFT - ISSUED FOR COMMENT | CNAS/CNAS/OLSS/PASS |
| REV. | DATE | DESCRIPTION | DES. DRW. CHK. APP. |

Designed: CNAS Date: 04/06/18
 Drawn: CNAS Date: 04/06/18
 Checked: OLSS Date: 04/06/18
 Approved: PASS Date: 04/06/18
 Owner: COWI Project No.: DDA-BSB Scale: AS NOTED
 Status: **PRELIMINARY**
 DO NOT SCALE FROM THIS DRAWING. ALL DIMENSIONS ARE IN mm, UNLESS OTHERWISE STATED.

Project: **BLOOD STONEY BRIDGE PRELIMINARY DESIGN STAGE (2A)**
 Drawing Title: **BLOOD STONEY BRIDGE GENERAL ARRANGEMENT PLAN AND ELEVATION - CLOSED**
 Drawing No.: **DDA-BSB-DRG-COWI-1005** Rev: **1.0**

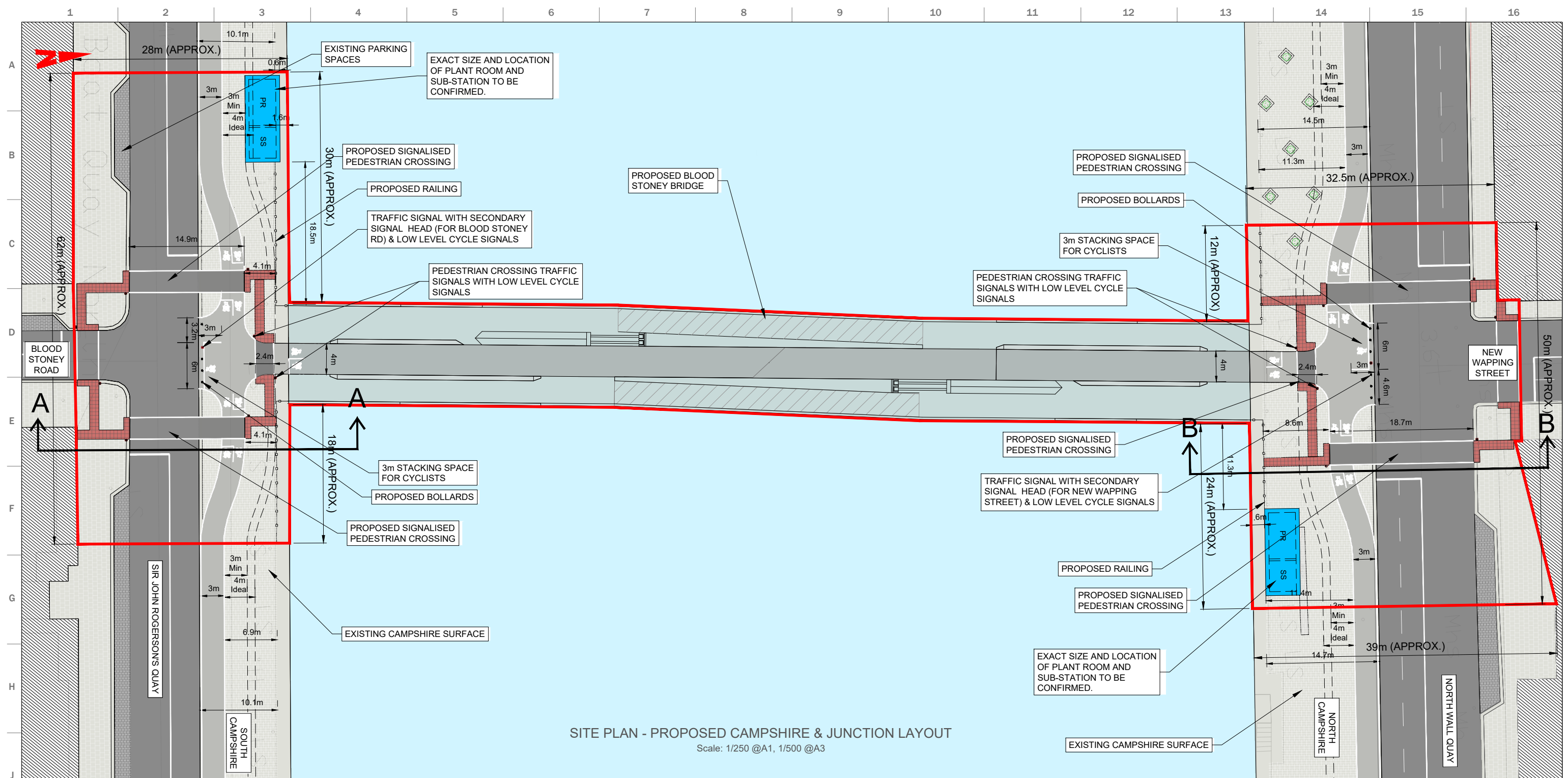

SITE PLAN - PROPOSED CAMPSHIRE & JUNCTION LAYOUT
 Scale: 1/250 @A1, 1/500 @A3

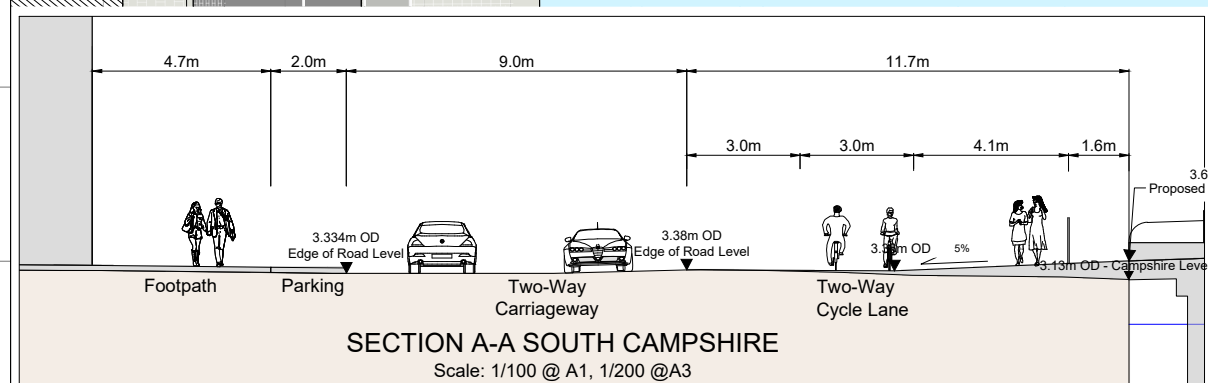

SECTION A-A SOUTH CAMPSHIRE
 Scale: 1/100 @ A1, 1/200 @A3

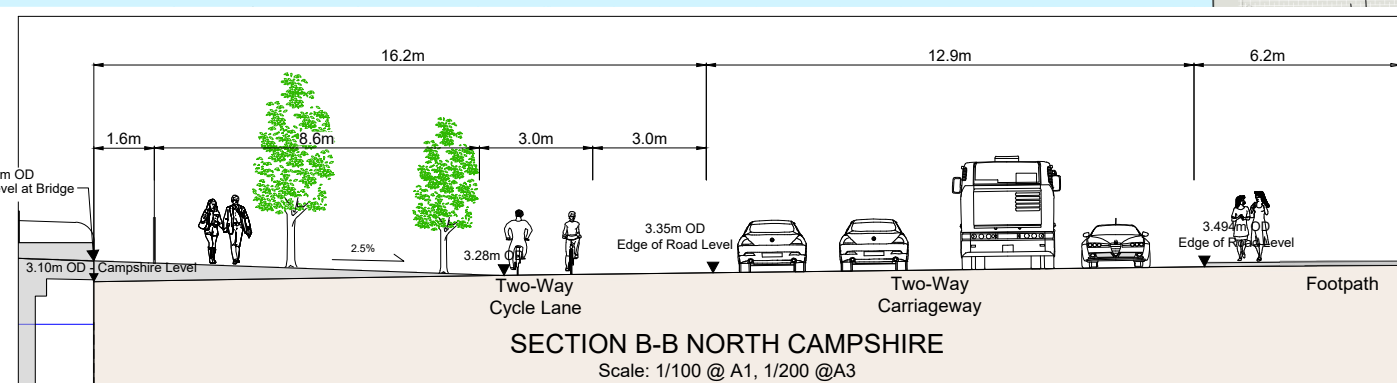

SECTION B-B NORTH CAMPSHIRE
 Scale: 1/100 @ A1, 1/200 @A3

LEGEND:

- Site Extents
- Cycle Zone / Cycle Track
- Existing Footpath
- Tactile Paving (Blister Surface)
- Cobbled Campshire Surface
- Existing Building
- Proposed Traffic Signal
- Ancillary Buildings
 PR: (Plant Room)
 SS: (Substation)
 11.25 x 4.5 x 3.5m H (Approx.)

Ordnance Survey
 © Ordnance Survey Ireland. All rights reserved. License number 2018/23/CCMA/DublinCityCouncil

Designers:

RPS COWI

Knight Architects **SAISON** Turner & Townsend

E: ireland@rpsgroup.com; or info_uk@cowi.com

Client:

Comhairle Cathrach Bhaile Atha Cliath
 Dublin City Council

| REV. | DATE | DESCRIPTION | DES. | DRW. | CHK. | APP. |
|------|------------|--------------------|------|------|------|------|
| 07 | 2019-11-13 | ISSUE FOR APPROVAL | JK | JK | MC | RT |
| 06 | 2018-10-09 | ISSUE FOR APPROVAL | MC | DC | MN | RT |
| 05 | 2018-08-03 | ISSUE FOR APPROVAL | MC | PH | MN | RT |
| 04 | 2018-07-31 | ISSUE FOR APPROVAL | MC | PH | MN | RT |
| 03 | 2018-07-31 | ISSUE FOR APPROVAL | MC | PH | MN | RT |
| 02 | 2018-07-19 | ISSUE FOR APPROVAL | MC | PH | MN | RT |
| 01 | 2018-07-18 | ISSUE FOR APPROVAL | MC | KMG | MN | RT |
| 00 | 2018-07-08 | ISSUE FOR APPROVAL | MC | KMG | MN | RT |

Designed: MC Date: 2018-07-06
 Drawn: KMG Date: 2018-07-06
 Checked: MN Date: 2018-07-06
 Approved: RT Date: 2018-07-06

Owner: RPS Project No.: DDA-BSB Scale: AS NOTED

Status: **APPROVAL**

DO NOT SCALE FROM THIS DRAWING. ALL DIMENSIONS ARE IN mm, UNLESS OTHERWISE STATED.

Project: **BLOOD STONEY BRIDGE**

Drawing Title: **PROPOSED CAMPSHIRE & JUNCTION LAYOUT**

Drawing No.: **DDA-BSB-DRG-RPS-4051**

Rev: **07**